

Zusatzaufgaben Vierecke konstruieren - Skizzen

1. Quadrat

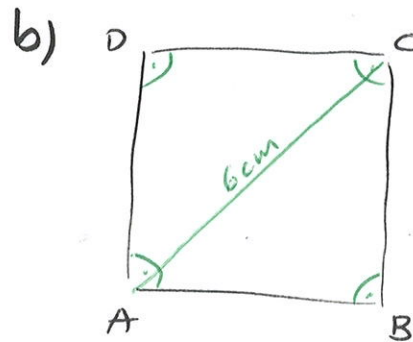

2. Rechtecke

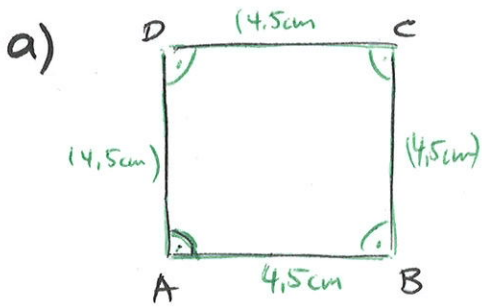
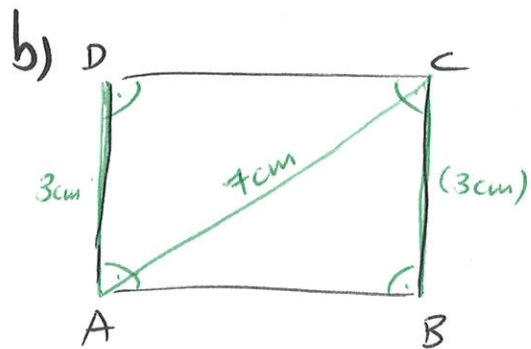
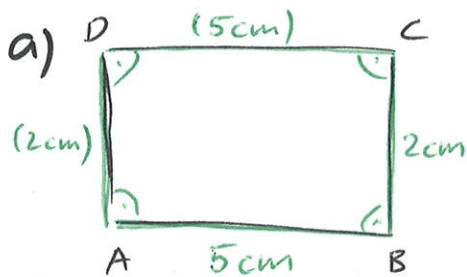

3. Rhombus

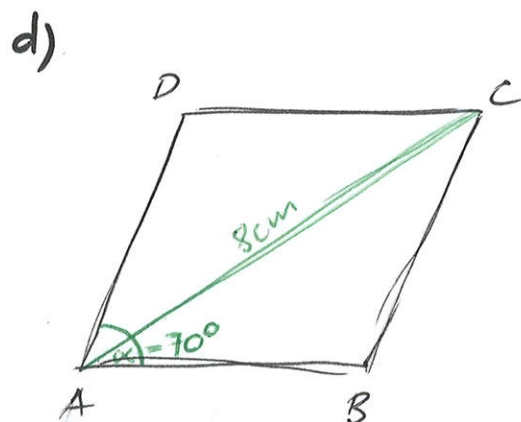
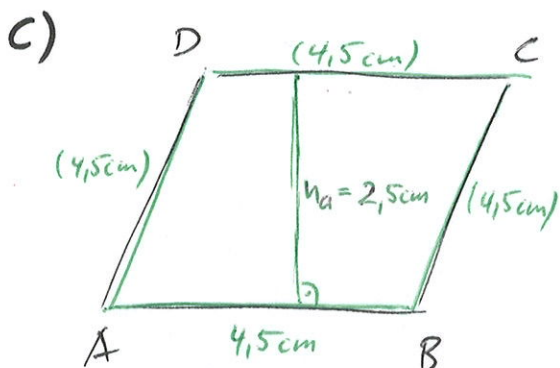
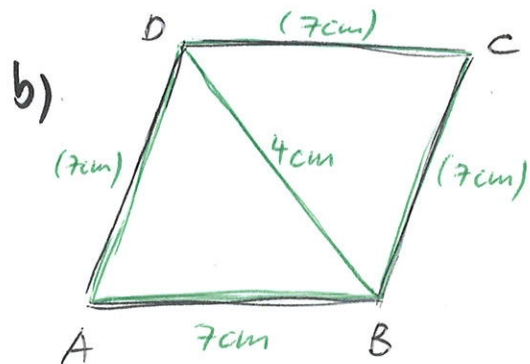
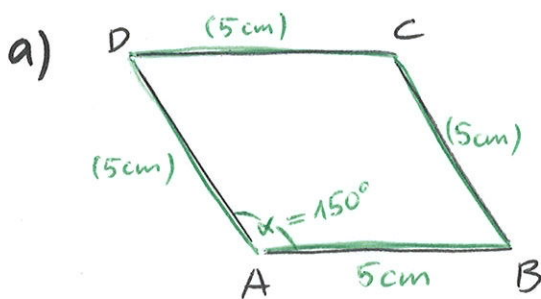

4. Parallelenviereck

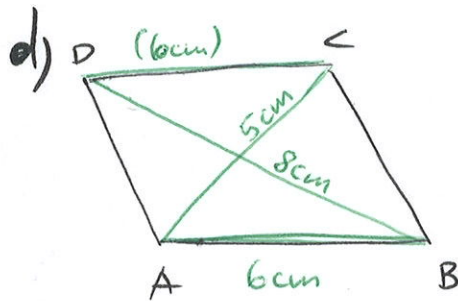
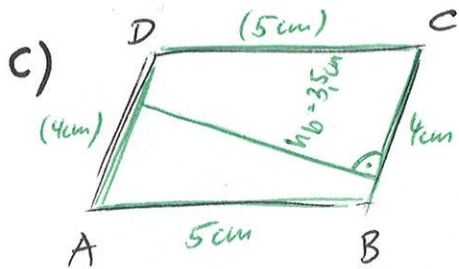
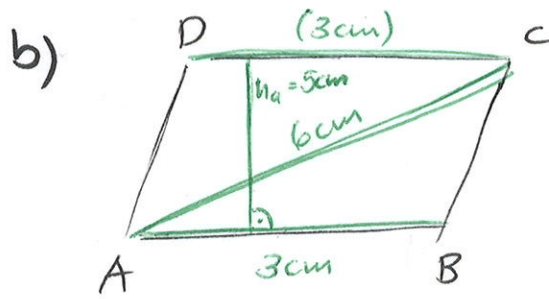
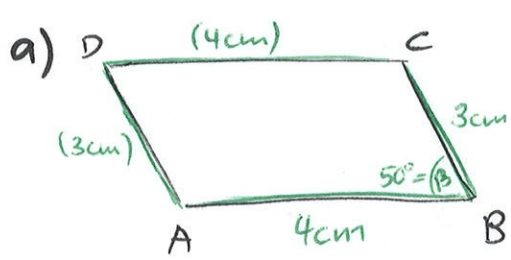

5. Trapez

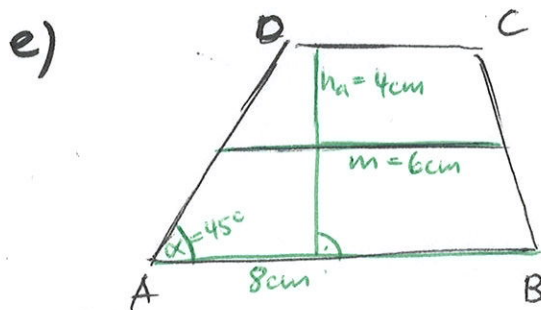
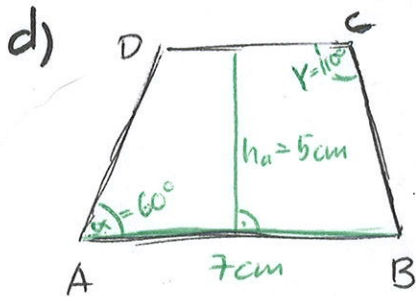
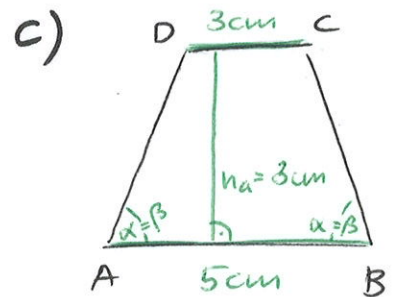
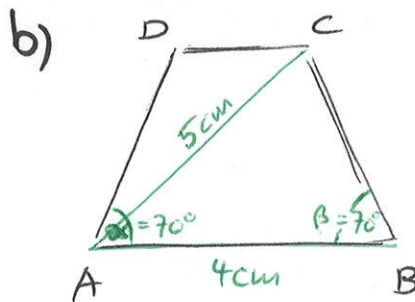
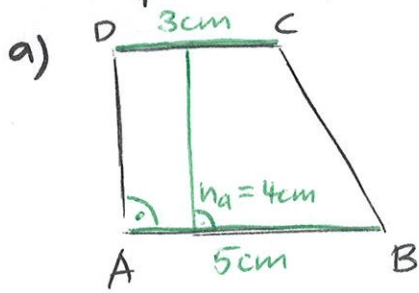

6. Drachen

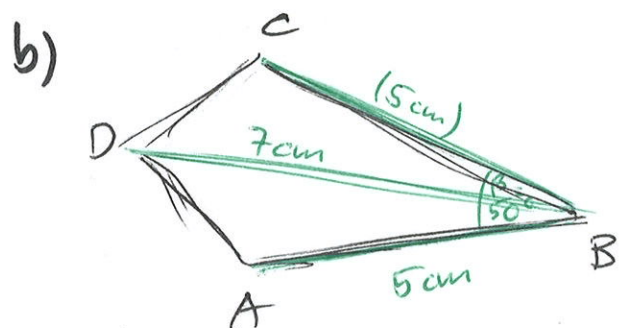
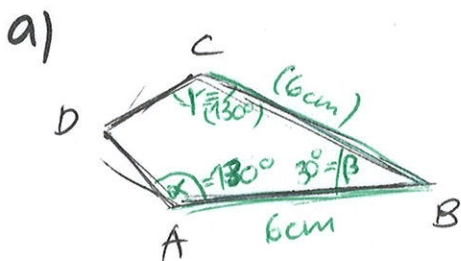

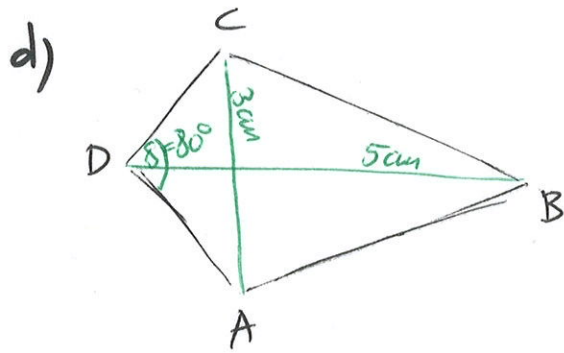
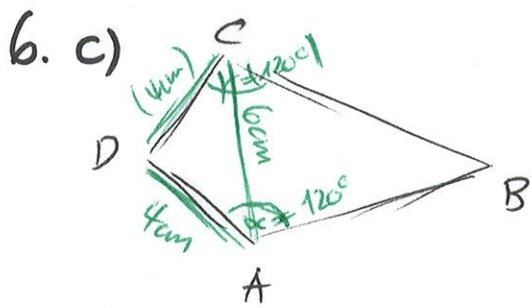

7. allgemeines Viereck

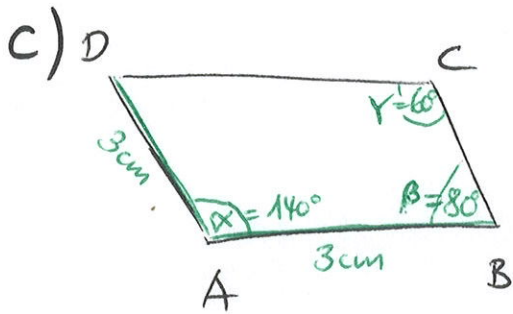
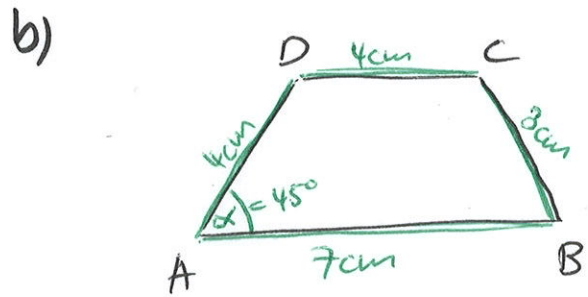
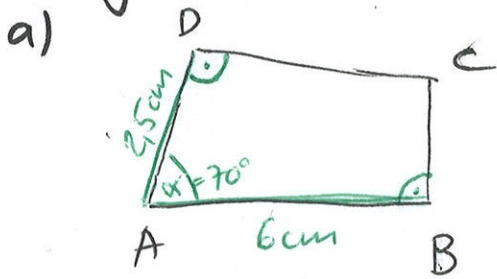

Zusatzaufgaben Vierecke konstruieren - Konstruktionen

1. Quadrat

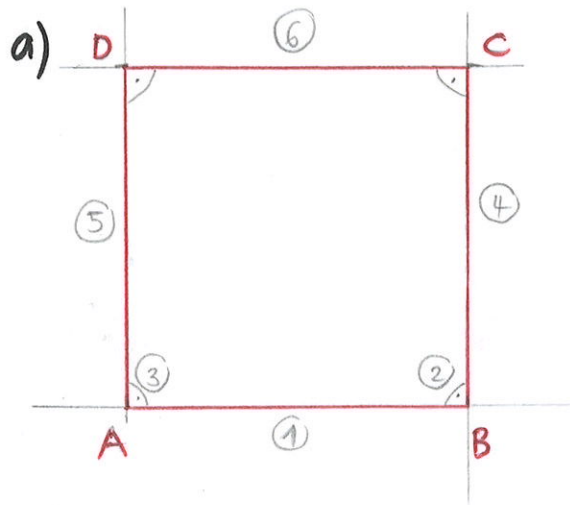

b)

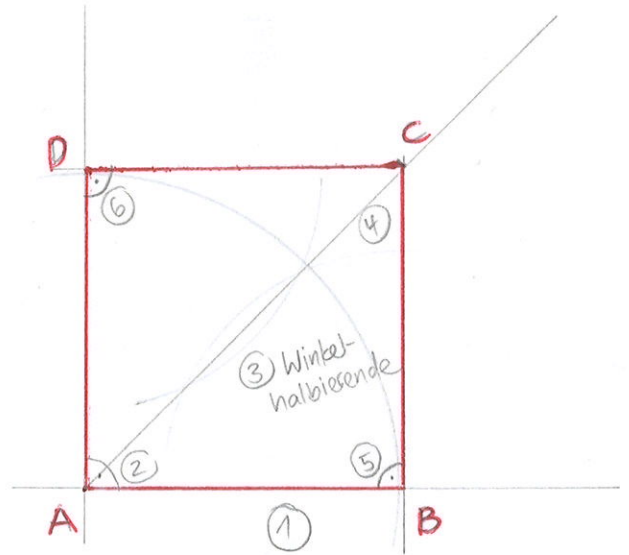

2. Rechteck

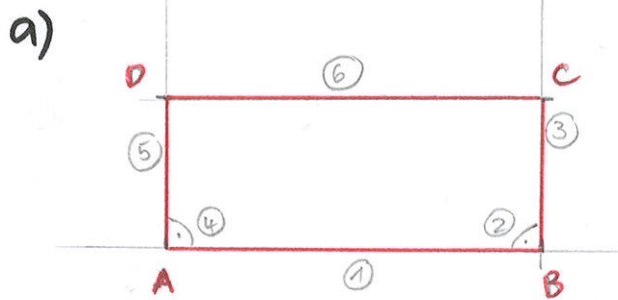

b)

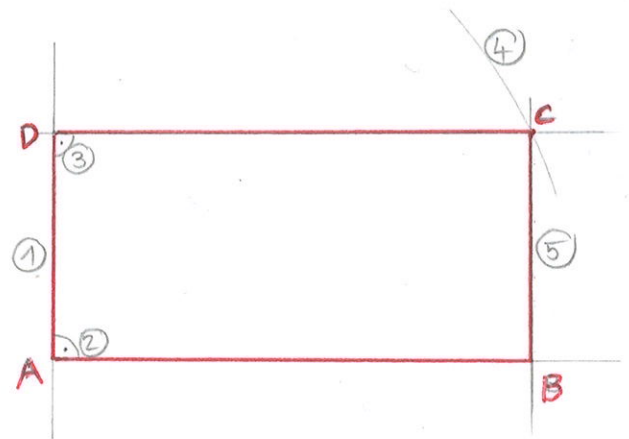

3. Rhombus

a)

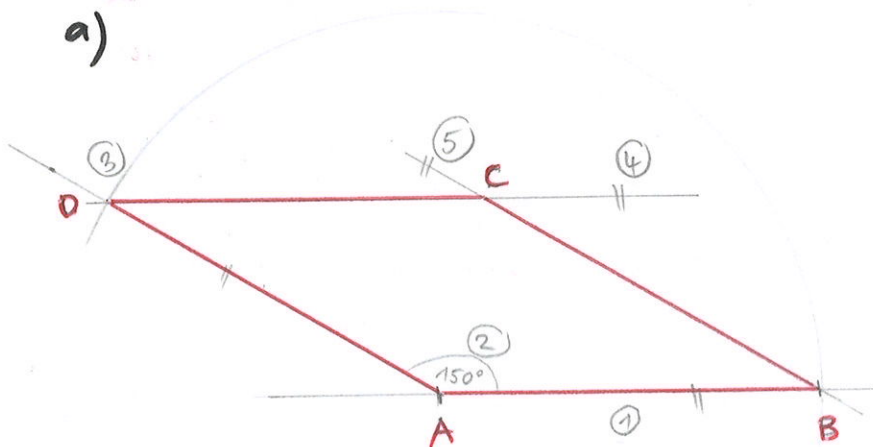

3. Rhombus

b)

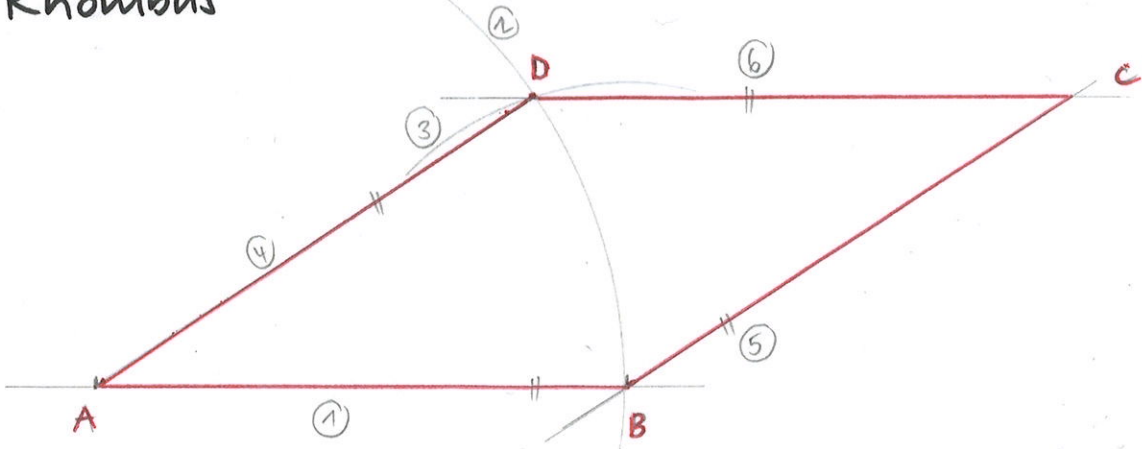

c)

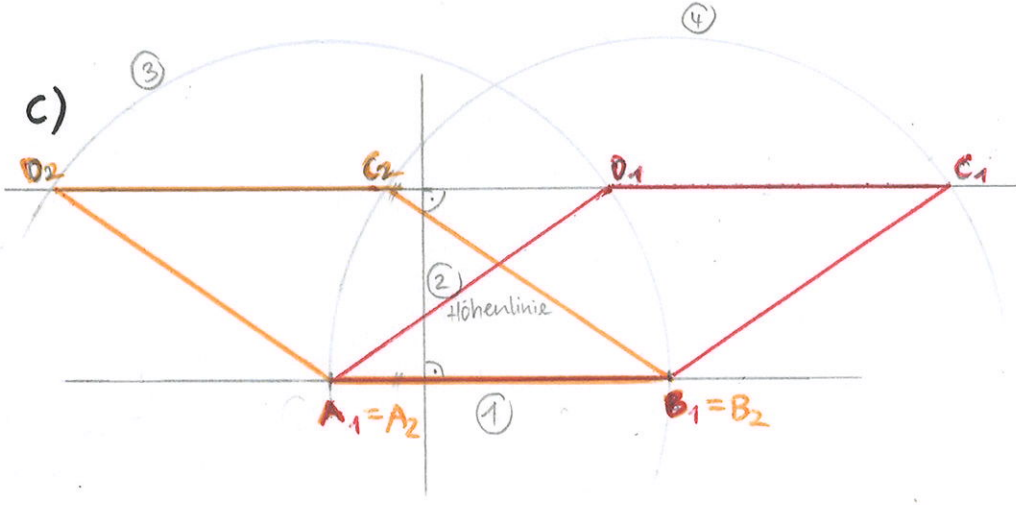

d)

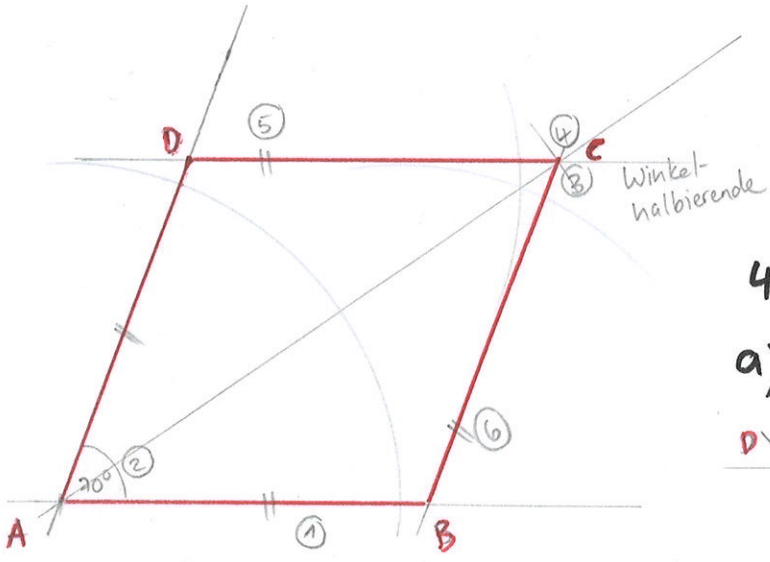

4. Parallelenviereck

a)

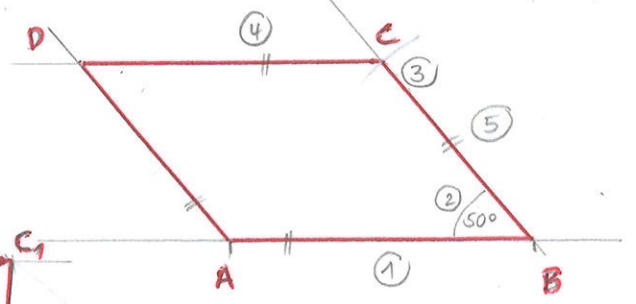

4.b)

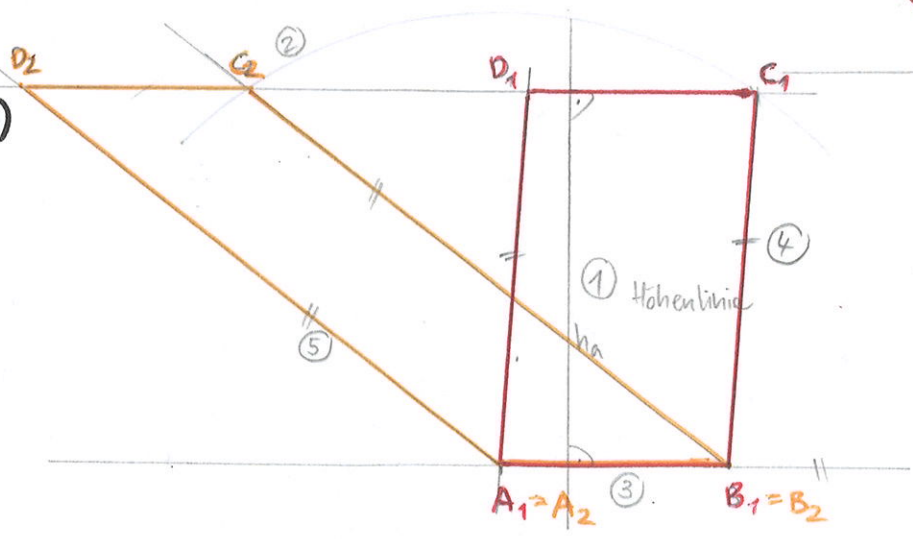

4.c)

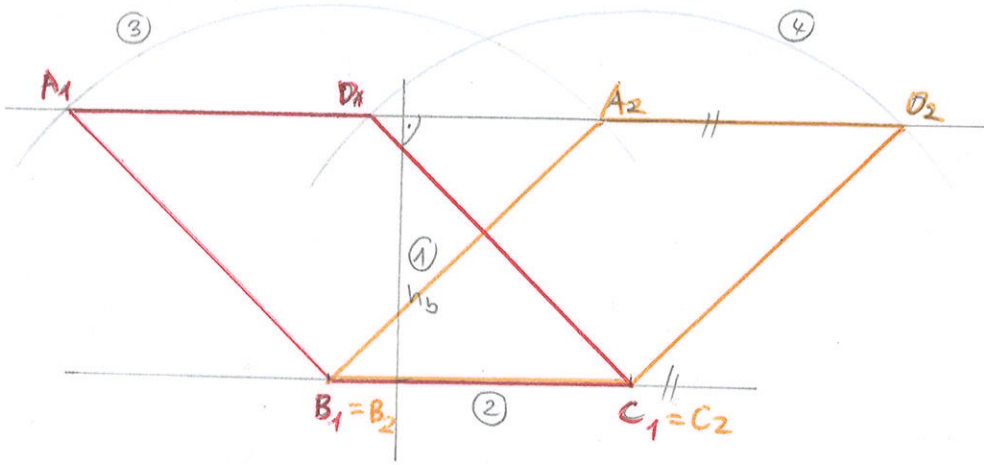

d)

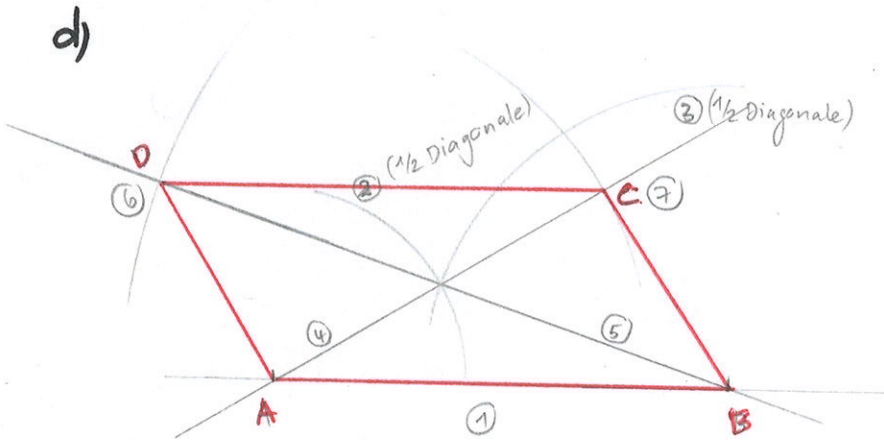

5. Trapez

a)

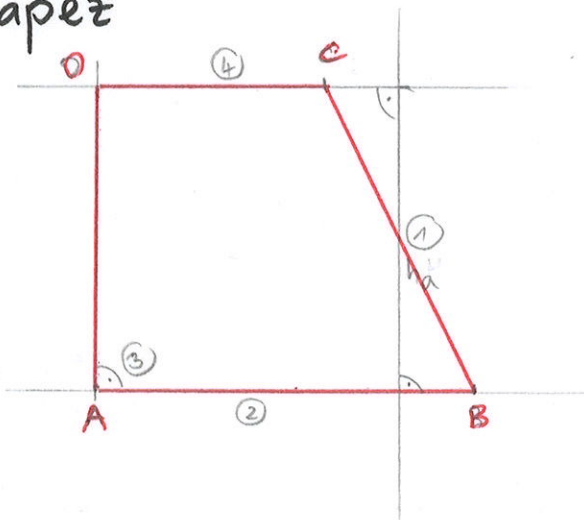

b)

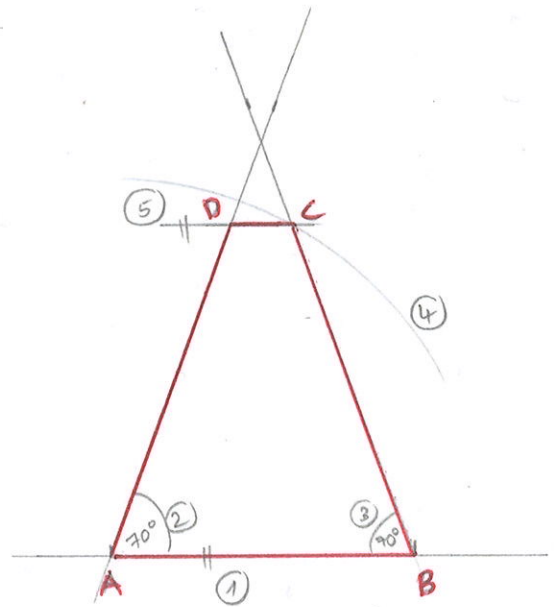

c)

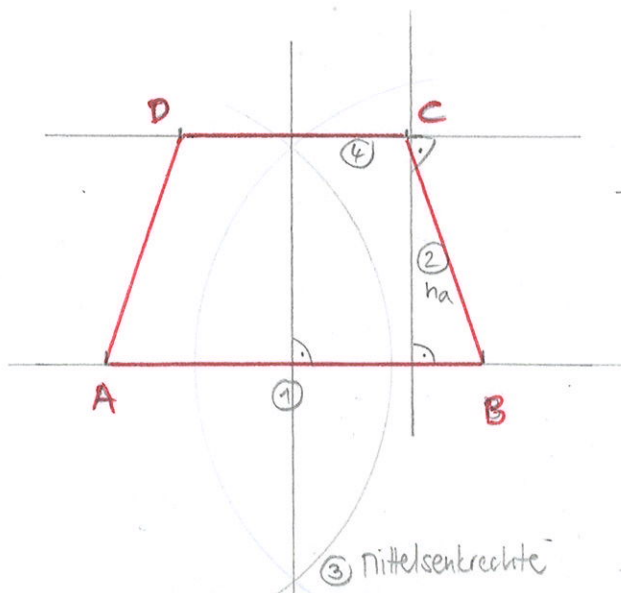

d)

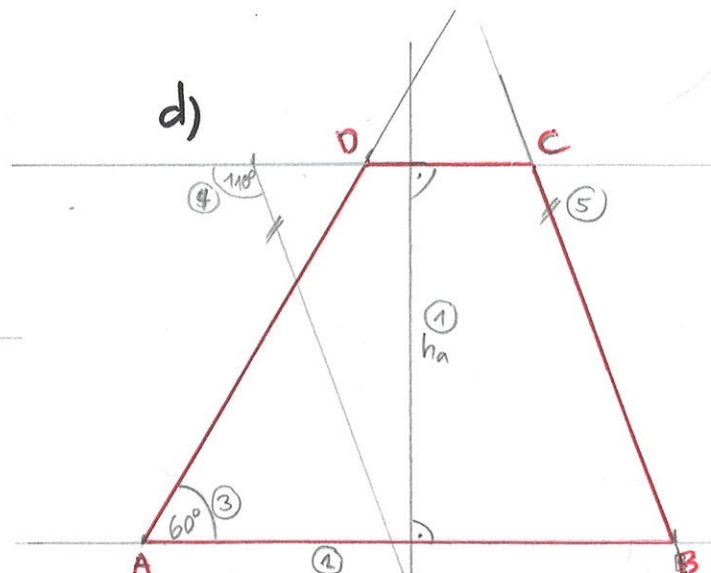

5.e)

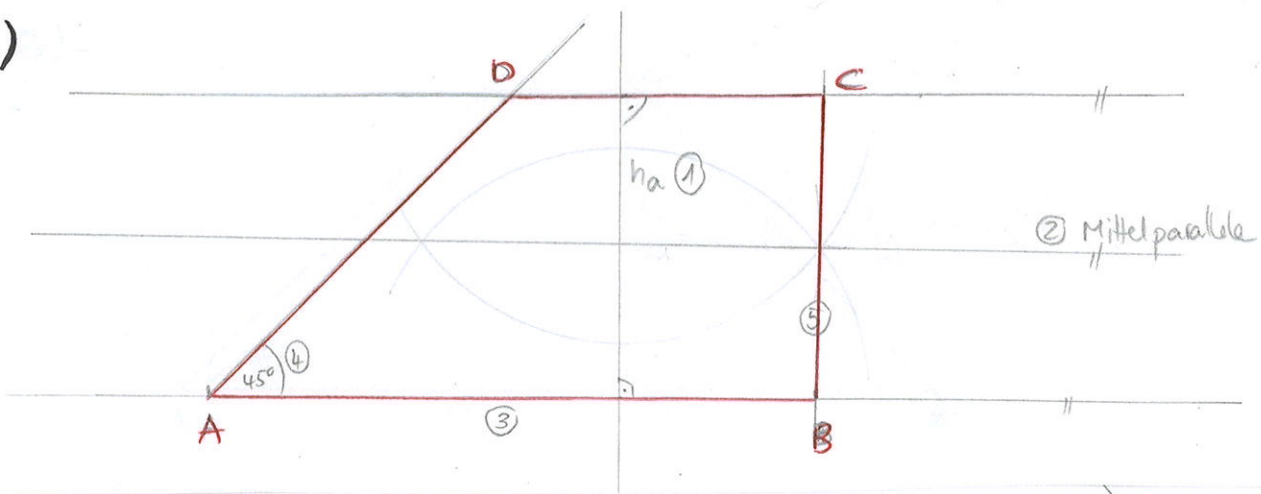

6. Drachen

a)

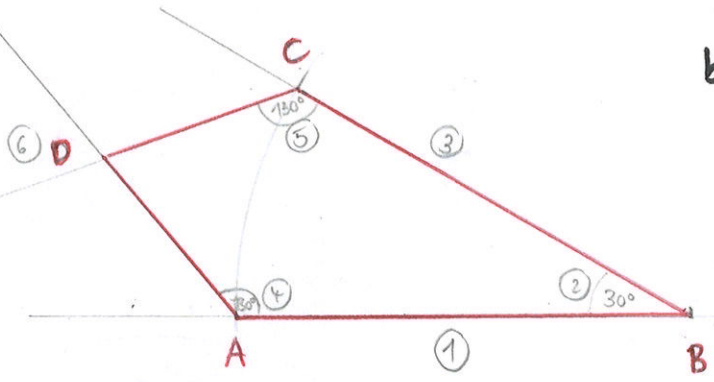

b)

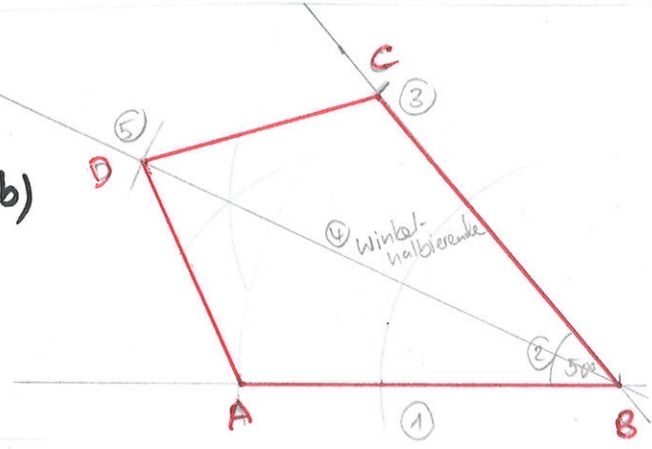

c)

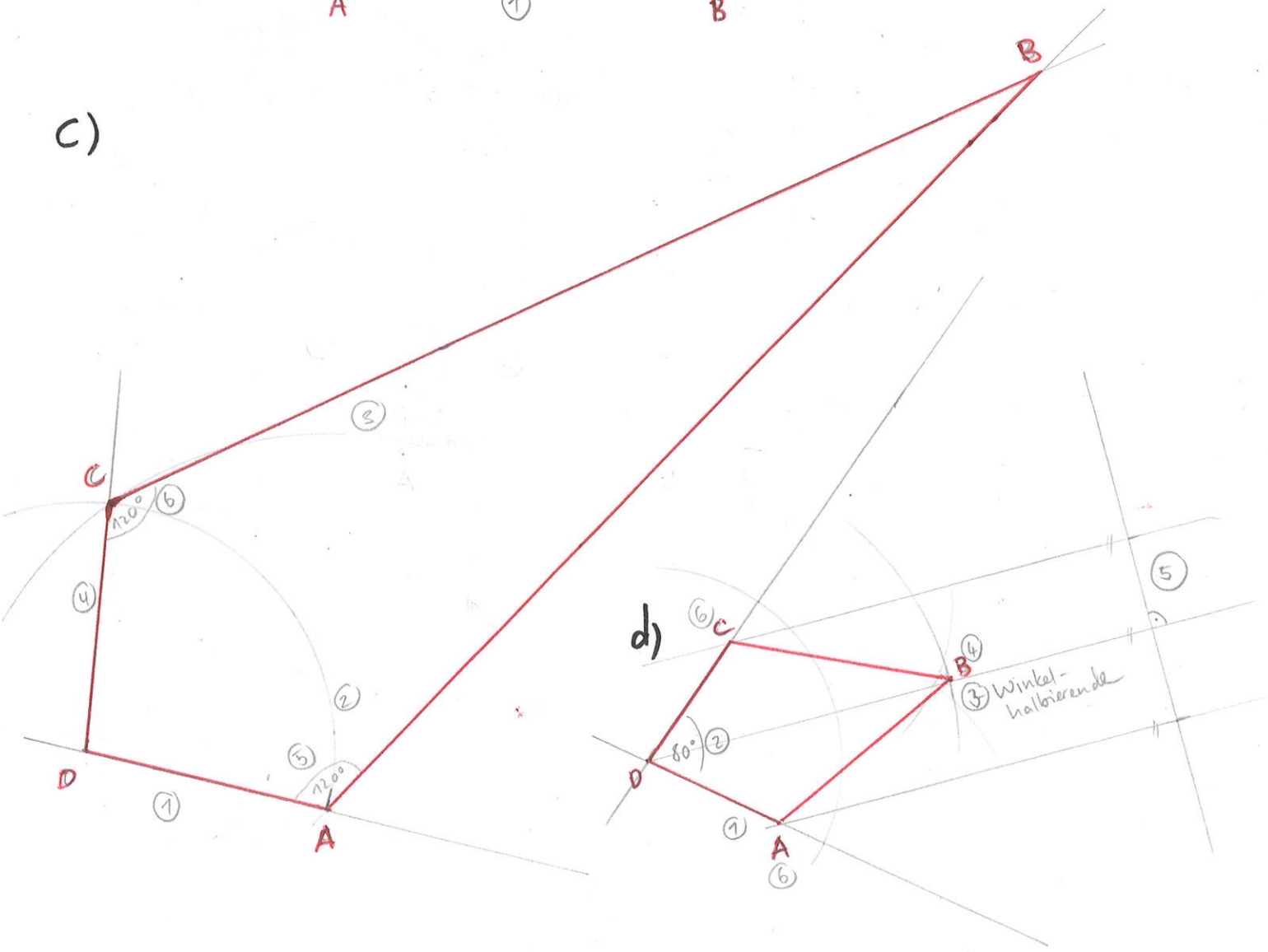

d)

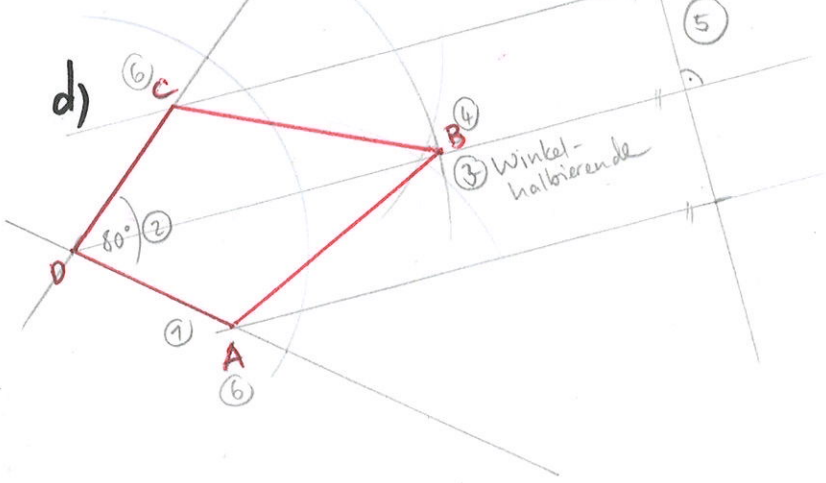

7. allgemeines Viereck

a)

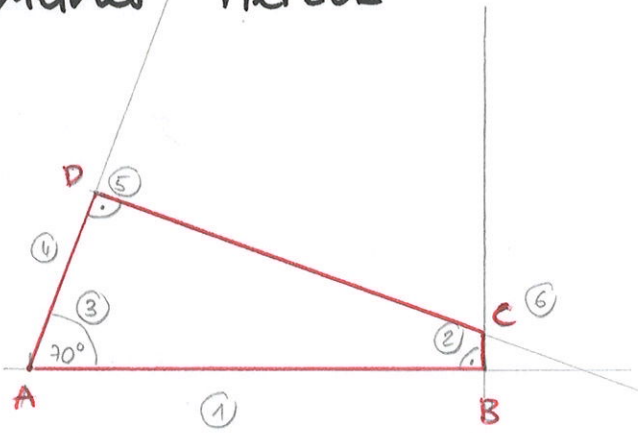

b)

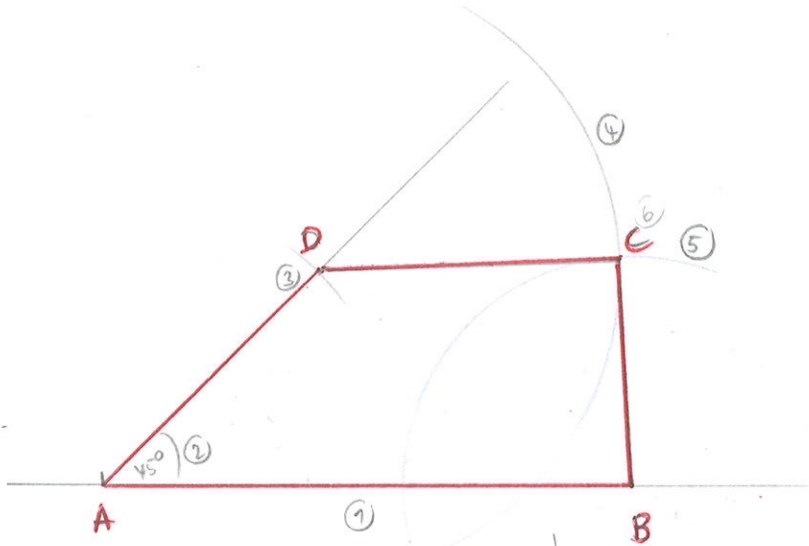

c)

